



ANNUNCIATOR 01

Master Moduke

Shape	Number of Windows	Unit Price(THB)
 Master Module	16 channels	28,000.-
	24 channels	34,800.-
	32 channels	41,600.-
	40 channels	48,400.-
	48 channels	55,200.-
	56 channels	62,000.-

*Rated Voltage can be supply upon request.

Display Moduke

Shape	Description	Unit Price/window (THB)
 Display Module	30 x 30 mm. / Window(With LED)(BA9S)	850.-
	30 x 60 mm. / Window(With LED)(BA9S)	1,250.-

ESPAN01 / D3Y - D11 - 4/2

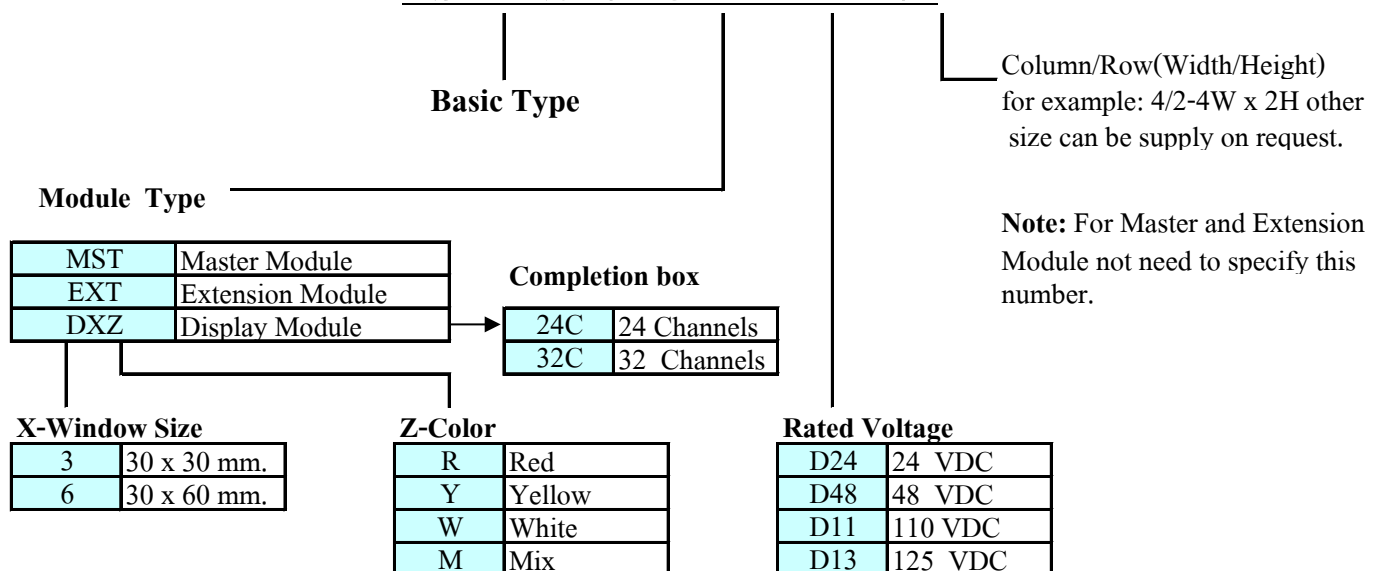

ANNUNCIATOR 02

Shape	Code	Description	Unit Price/window (THB)
	ESPAN02E	Without relay output	3,000.-
	ESPAN02	With relay output	3,200.-

ESPAN02 E / 16 - D11 - R

Basic Type

Option

R	Ringback
---	----------

Fault Output

none	Including Output Contacts
E	Excluding Output Contacts

Rated Voltage

24	24V
48	48V
11	110V
13	125V
22	220V



Number of Windows

09	9 windows (3H x 3W)
12	12 windows (3H x 4W)
16	16 windows (4H x 4W)
18	18 windows (3H x 6W)
20	20 windows (4H x 5W)
24	24 windows (4H x 6W)
28	28 windows (4H x 7W)
30	30 windows (5H x 6W)
32	32 windows (4H x 8W)
35	35 windows (5H x 7W)
36	36 windows (6H x 6W)
40	40 windows (5H x 8W)
48	48 windows (6H x 8W)

Supply Type

D	DC
A	AC 50/60Hz.

ACCESSORIES'02

Shape	Description	Unit Price (THB)
	Logic module	3,300.-
	LED module	700.-

ANNUNCIATOR 03

Shape	Code	Description	Unit Price (THB)
	ESPAN03/8	8 CHANNEL	15,000.-
	ESPAN03/16	16 CHANNEL	17,000.-

ESPAN03 / 16 - D 13

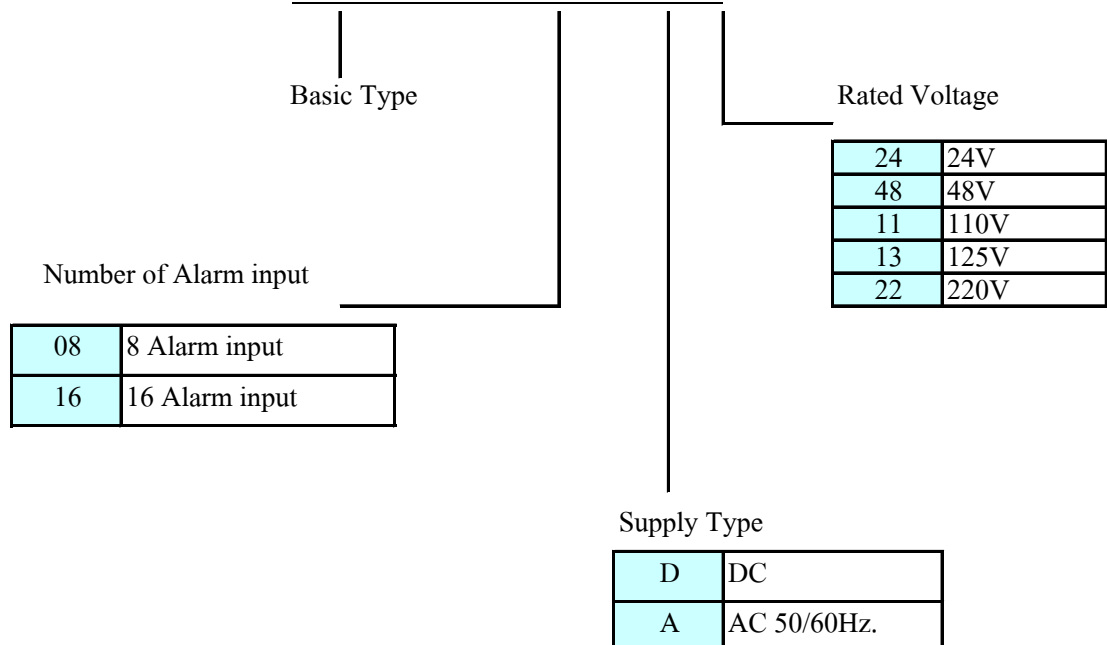

VIBRATING HORN

Shape	Description	Unit Price (THB)
	VH-D24C : DC 24V	5,000.-
	VH-D48C : DC 48V	
	VH-D11C : DC 110V	
	VH-D13C : DC 125 V	

POWER BUZZER

Shape	Description	Unit Price (THB)
	PBZ-D24 : DC 24V	1,450.-
	PBZ-D48 : DC 48V	
	PBZ-D11 : DC 110V	
	PBZ-D13 : DC 125V	
	PBZ-A22 : AC 220V	

DC VOLTAGE MONITORING RELAY

Shape	Description	Unit Price (THB)
	E27D	6,000.-
	with AC aux. supply	600.-

FAST TRIP RELAY

Shape	Description	Unit Price (THB)
	E94-3	5,000.-
	E94-6	6,250.-

LATCHING RELAY

Shape	Description	Unit Price (THB)
	EL04	6,250.-
	EL08	8,750.-

DIODE BOX

Shape	Description	Unit Price (THB)
	LTB0110	1,500.-