

**PILOT LIGHT**



**Pilot light with LED NA9S**



**Pilot light with FLED**

**NPL- 22 - R 13 - L**

**Basic Type** \_\_\_\_\_

**Cut out** \_\_\_\_\_

16	16mm.(Fix type only)
22	22mm.

**Lens Color** \_\_\_\_\_

R	Red
G	Green
Y	Yellow
W	White
S	Sky blue
O	Orange

**Lamp Type**

L	LED(BA9S), removable
F	Fix LED

**Rated Voltage of Lamp**

24	AC-DC 24V
48	AC-DC 48V
110	AC-DC 110V
125	AC-DC 125V
220	AC-DC 220V

Rated Voltage	Unit Price (THB)	
	LED	FLED
AC-DC 24V	275.-	170.-
AC-DC48V		
AC-DC 110V		
AC-DC 125V		
AC-DC 220V		

\*ราคานี้ยังไม่รวม VAT 7% และ ราคาอาจมีการเปลี่ยนแปลงโดยไม่ต้องแจ้งล่วงหน้า

**LED LAMP**



**NA9S- R 13 - 10**

Socket Type _____		LED Diameter	
NA9S	Bayonet base 9mm.	10	10mm.
NE10	Screw-in base 10mm.	14	14mm.
Emitting Color _____		Rated Voltage of Lamp	
R	Red	24	AC-DC 24V
G	Green	48	AC-DC 48V
A	Amber	11	AC-DC 110V
W	White	13	AC-DC 125V
S	Sky blue	22	AC-DC 220V

Rated Voltage	Unit Price (THB)	
	NA9S	NE10
AC-DC 24V	150.-	150.-
AC-DC48V		
AC-DC 110V		
AC-DC 125V		
AC-DC 220V		

\*ราคานี้ยังไม่รวม VAT 7% และ ราคาอาจมีการเปลี่ยนแปลงโดยไม่ต้องแจ้งล่วงหน้า

## PUSH BUTTON SWITCH



### NPB22 - R 13-A 11

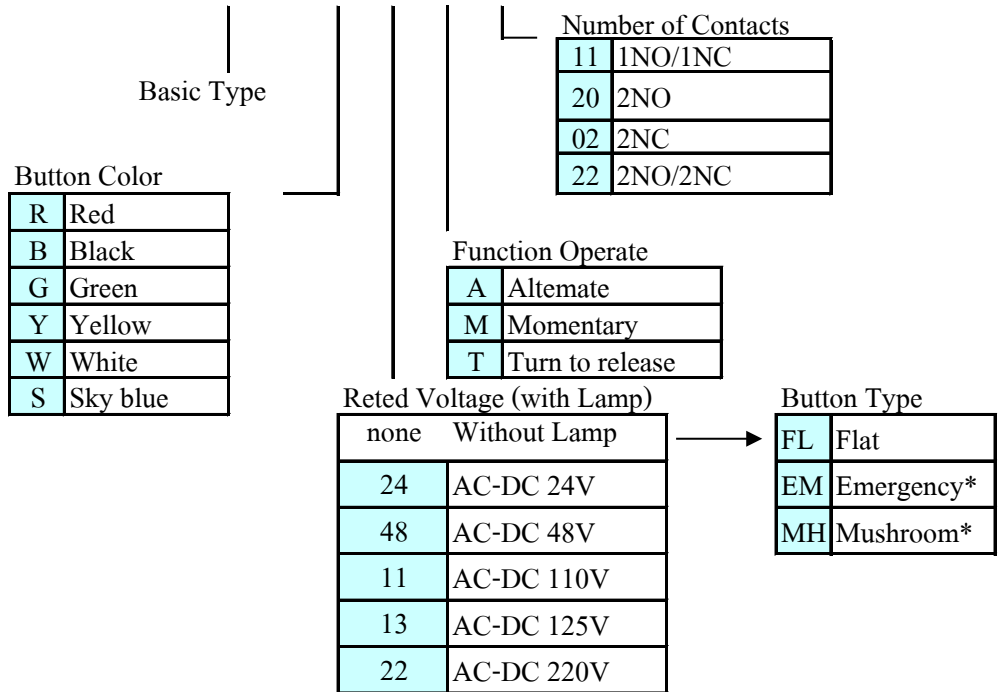

\***Note** : Mushroom head push button has red and green color only.

Emergency push button has red color only.

Button Type	Unit Price (THB)		Addition Contact (2 Contacts/Unit)
	2 Contacts with Lamp	2 Contacts without Lamp	
Flat	440.-	200.-	150.-
Emergency	-	300.-	
Mushroom	-	300.-	

**SELECTOR SWITCH**

**NSS22 - 2 L - 11**

Basic Type



Number of Contacts

11	1NO/NC
20	2NO
2C	2NC
22	2NO/2NC

Handle Type

L	Long
S	Short

Working Steps

2	2 Steps
3	3 Steps

Handle Type	Steps	Unit Price (THB)	Addition Contacts*
Short	2	280.-	150.-
	3	280.-	
Long	2	-	
	3	-	

**SEMAPHORE INDICATOR**

**NSI22R\*- E 13**

Basic Type



Rated Voltage

24	AC - DC 24V
48	AC - DC 48V
11	AC - DC 110V
13	AC - DC 125V
22	AC - DC 220V

Working Status

D	Draw out status of breaker or DS
E	Grounding or earth of breaker or DS
S	Operation status of breaker or DS

Rated Voltage	Unit Price(THB)
AC-DC 24V	1,250.-
AC-DC 48V	
AC-DC 110V	
AC-DC 125V	
AC-DC 220V	

\*W = WHITE, B = BLACK

### MINIATURE BUZZER

Shape	Product Coding	Unit Price(THB)
	NBZ-110,210 VDC	300.-

### SPACE HEATER

Shape	Product Coding	Unit Price(THB)
	NSH-050	1,235.-
	NSH-100	
	NSH-150	

### THERMOSTAT

Shape	Product Coding	Unit Price(THB)
	NTH	900.-

## LIMIT SWITCH

Shape	Product Coding	Unit Price(THB)
	NLS-DS	350.-
	NLS-SA020-1A	350.-
	Z-15GQ-B	250.-
	Z-15GW-B	220.-
	Z-15GW2-B	250.-
	Z-15GW22-B	210.-

## TIME SWITCH

Shape	Product Coding	Unit Price(THB)
	NTS-24HR	2,500.-

\*ราคานี้ยังไม่รวม VAT 7% และ ราคาอาจมีการเปลี่ยนแปลงโดยไม่ต้องแจ้งล่วงหน้า

## UNIVERSAL OUTLET

Shape	Product Coding	Unit Price(THB)
	NDO	150.-

## SERVICE LAMP

Shape	Product Coding	Unit Price(THB)
	NSL-OL	625.-

## PANEL METER

### Moving Coil AC/DC Ammeters and Voltmeters

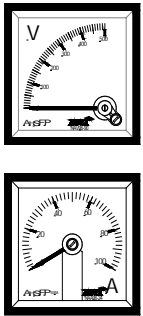
Shape	Product Coding	Unit Price(THB)
	NDA96-90	1,300.-
	NAA96-90	1,700.-
	NDA96-24	
	NAA96-24	
	NDV96-90	1,100.-
	NAV96-90	1,400.-
	NDV96-24	
	NAV96-24	
	DC METER 4.20mA, 90°	1,800.-

## FUSE DISCONNECTOR

Shape	Product Coding	Unit Price(THB)
	NFD10-1P	170.-
	NFD10-2P	340.-
	NFD10-3P	510.-

\*ราคานี้ยังไม่รวม VAT 7% และ ราคาอาจมีการเปลี่ยนแปลงโดยไม่ต้องแจ้งล่วงหน้า

## CURRENT TRANSFORMER



Product Coding	CT Ratio (A)	Unit Price(THB)
NCT-30-030	30/5	420.-
NCT-30-050	50/5	
NCT-30-060	60/5	
NCT-30-080	80/5	
NCT-30-100	100/5	
NCT-40-150	150/5	570.-
NCT-40-200	200/5	
NCT-40-250	250/5	
NCT-40-300	300/5	
NCT-40-400	400/5	
NCT-60-500	500/5	820.-
NCT-60-600	600/5	
NCT-60-750	750/5	
NCT-60-800	800/5	
NCT-60-1000	1000/5	
NCT-100-1500	1500/5	1,870.-
NCT-100-2000	2000/5	2,500.-
NCT-100-2500	2500/5	3,200.-
NCT-100-3000	3000/5	3,750.-
NCT-125-1500	1500/5	3,750.-
NCT-125-2000	2000/5	5,000.-
NCT-125-2500	2500/5	6,250.-
NCT-125-3000	3000/5	7,500.-
NCT-125-4000	4000/5	10,000.-
NCT-125-5000	5000/5	12,500.-

\*ราคานี้ยังไม่รวม VAT 7% และ ราคาอาจมีการเปลี่ยนแปลงโดยไม่ต้องแจ้งล่วงหน้า



**CAM SWITCH**



**NCS - 20 M1 - 06**

Basic Type

Rated Operated Current

20	20A
25	25A

Escutcheon Plate

M1	Dimension 48 x 48mm.
M2	Dimension 64 x 64mm.

Number of Contacts

02	2 Contacts
04	4 Contacts
06	6 Contacts



24	24 Contacts
----	-------------

Model Number of Contacts	Plate M1		Plate M2	
	NCS-20	NCS-25	NCS-20	NCS-25
2	700.-	750.-	850.-	900.-
4	950.-	1,000.-	1,100.-	1,150.-
6	1,200.-	1,250.-	1,350.-	1,400.-
8	1,450.-	1,500.-	1,600.-	1,650.-
10	1,700.-	1,750.-	1,850.-	1,900.-
12	1,950.-	2,000.-	2,100.-	2,150.-
14	2,200.-	2,250.-	2,350.-	2,400.-
16	2,450.-	2,500.-	2,600.-	2,650.-
18	2,700.-	2,750.-	2,850.-	2,900.-
20	2,950.-	3,000.-	3,100.-	3,150.-
22	3,200.-	3,250.-	3,350.-	3,400.-
24	3,450.-	3,500.-	3,600.-	3,650.-

With key operate	+ 550.- / item
Accessory for parallel installation	+ 230.- / item

## HYGROSTAT

Shape	Product Coding	Unit Price(THB)
	NMH	2,500.-

## DC SHUNT

Shape	Product Coding	Unit Price(THB)
	NDS-060	1,100.-
	NDS-100	1,100.-
	NDS-150	1,100.-
	NDS-200	1,200.-
	NDS-250	1,200.-
	NDS-400	1,375.-
	NDS-600	1,375.-

## INDUSTRIAL POWER RELAY

Shape	Product Coding	Unit Price(THB)
	NP403-D110	1,250.-
	SP403(SOCKET)	450.-

## ELECTRO-MAGNETIC

Shape	Product Coding	Unit Price(THB)
	NEC	800.-

\*ราคานี้ยังไม่รวม VAT 7% และ ราคาอาจมีการเปลี่ยนแปลงโดยไม่ต้องแจ้งล่วงหน้า

## TIMER RELAY

Shape	Product Coding	Unit Price(THB)
	H3CR+Socket	1,400.-

## DISCREPANCY SWITCH

Shape	Product Coding	Unit Price(THB)
	NDCS-3	5,125.-
	NDCS-4	5,500.-
	NDCS-5	5,875.-
	NDCS-6	6,250.-

## LINE LAMP

Shape	Product Coding	Unit Price(THB)
	NLL-3	850.-
	NLL-6	1,250.-